







Arche



LED			
230 V 50 Hz	UGR <19	IP 20	IP 40
CRI 80	80000 L80B50		
SDCM 3	EVG DIMM		

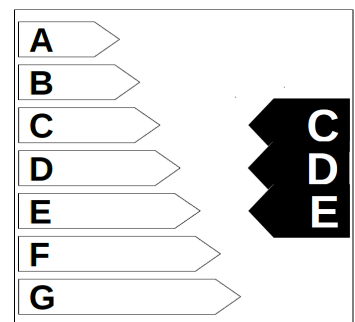

Body:

White painted (RAL 9003) aluminium frame

Optic:

Transluce acrylic desk

KO – opal cover

KN – microprismatic cover

Version (body shape)

Arche..A 600 (625) – square 600x600 mm (625x625)

Arche..B 600 – rectangle 600x300 mm

Arche..C 600 – rectangle 1200x300 mm

Installation way:

Arche – recessed installation into modular ceiling 600 or 625 mm. Using accessories the panel can be also installed as surface or recessed into a gypsum plasterboard.

Arche P – surface or recessed installation into modular ceiling 600 or 625 mm. Using accessories the panel can be also UNI 2 installed as pendant or recessed into a gypsum plasterboard

Accessories:

UQRAM – white painted aluminium frame for surface installation

ZH/UNI2 - universal 2-wires suspension

QVESTRAM – white painted aluminium frame for recessed installation into a gypsum plasterboard

51009913 – magnetic holder for surface installation on a gypsum plasterboard

VESTRAMA600 – white painted metal frame for recessed installation into gypsum plasterboard ceiling

NM – independent emergency module

VESTSET – set of clips for recessed installation into modular ceiling with hidden profiles

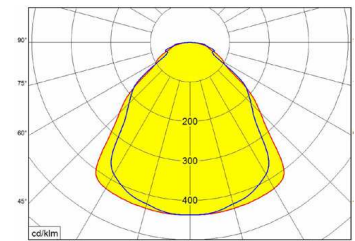

Arche KN

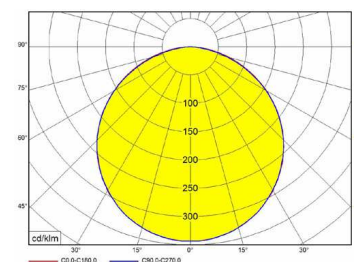

Arche KO

Frame

Connector

Back plate

Arche P



Codes: Arche4000A3KN600/ND

Arche	4000	A	3	KN	600	/ND
Luminaire type Arche - recessed / pendant fitting Arche P recessed / surface / pendant fitting	Luminaire light output	Body shape A - square - 600x600 mm B - rectangle - 600x300 mm C - rectangle - 300x1200 mm	Color temperature: 3 = 3000K 4 = 4000K 5 = 5000K	Cover type: KN – microprizma KO – opal	Modul 600 625	Driver type: ND – no dimmable DALI – dimmable DALI

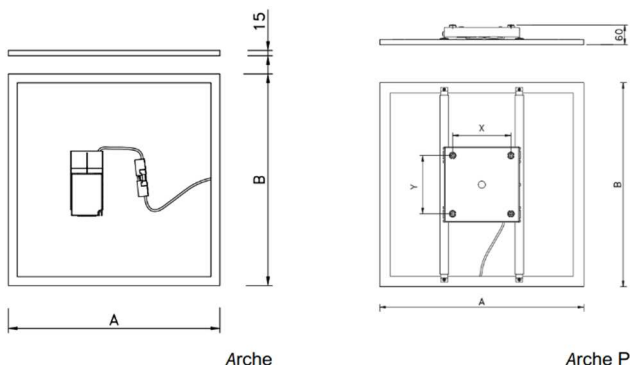

	W	lm		module 600		module 625		kg
		KO	KN	A	B	A	B	
Arche3000A	24	3000	3100	596	596	622	622	5,0
Arche4000A	35	4400	4500					
Arche5000A	49	5500	5700					
Arche6000A	57	6300	6600					
Arche2000B	16	1950	2000	596	296	622	310	2,8
Arche4000B	35	3800	4000					
Arche4000C	35	4100	4200					
Arche6000C	57	6200	6400	1196	296	1245	310	5,0
Arche3000A/90	24	x	2650	596	596	622	622	
Arche4000A/90	35	x	3950					
Arche5000A/90	49	x	5000					
Arche6000A/90	57	x	5650					

	W	lm		module 600		module 625		kg
		KO	KN	A	B	A	B	
Arche3500A	27	3700	3800	596	596	622	622	5,0
Arche4500A	35	4800	4900					

	W	lm		module 600		module 625		X/R	Y/S	kg
		KO	KN							
ArcheP3000A	24	3000	3100	596	596	622	622	170	170	5,3
ArcheP4000A	35	4400	4500							
ArcheP5000A	49	5500	5700							
ArcheP6000A	57	6300	6600							
ArcheP4000C	35	4100	4200	1196	296	1425	310	410	90	
ArcheP6000C	57	6200	6400							

lm - luminous flux of light fitting

Due to program of products development a data can be changed without notice. Luminous flux and connected electrical load are subject to an initial tolerance of up to +/- 10%. Color temperature is subject to a tolerance of up to +/-150 K from the nominal value. The failure of 1 LED points causes no functional impairment to the lighting performance of the luminaire and is therefore no reason for complaint.